

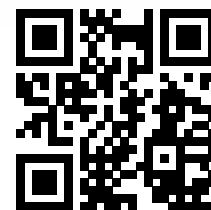





6 SERIES

<http://tiny.cc/6seriesEN>

 TIPPING LOAD 1200 kg	 ENGINE POWER 28 hp	 SPEED 15* km/h	 FLOW RATE 46 l/min	 LIFT HEIGHT 2,92 m
--	---	--	--	--

(*) 6.3S

Model	6.3	6.3+	6.3S
Engine	Yanmar 3TNV76		
Power (Iso Gross)	28 HP		
Fuel	Diesel		
Transmission	Hydrostatic		
Drive speed (max.)	13 km/h (8.1 mph)	11 km/h (6.8 mph)	15 km/h (9.3 mph)
Aux. hydraulics oil flow	46 l/min (12.2 gal/min)		
Max. lifting height	2,92 m (115 in)		
Tipping load, max ⁽¹⁾	1200 kg (2646 lbs)		
Lifting capacity straight ⁽²⁾	960 kg (2116 lbs)		
Lifting capacity fully articulated ⁽³⁾	780 kg (1720 lbs)		
Breakout force / 50 cm	1400 kg (3086 lbs)		
Pushing force (c)	900 kgf (900 kp)	1690 kgf (1690 kp)	1160 kgf (1160 kp)
Specific ground pressure (w/standard tires)	1022 kg/m ² (209 lbs/sqft)	1044 kg/m ² (214 lbs/sqft)	
Turning radius: inside/outside	905/2020 mm (35.6/79.5 in)		
Standard tires (Tractor profile)	23X8.50-12		
Weight	1400 kg (3086 lbs)	1430 kg (3153 lbs)	
Product Code	C961000	C961010	C961005
Price			

Tires size	Width (N)	Height (Q)
23X8.50-12	1070 mm (42 in)	2020 mm (79.5 in)
23X10.50-12 ⁽⁴⁾	1130 mm (44.5 in)	2020 mm (79.5 in)
26X12.00-12 ⁽⁴⁾	1300 mm (51.2 in)	2040 mm (80.3 in)
27X8.50-15	1070 mm (42 in)	2080 mm (81.9 in)
27X10.50-15 ⁽⁴⁾	1150 mm (45.3 in)	2080 mm (81.9 in)

⁽¹⁾ Maximum load that can be lifted just off the ground when the machine is straight, with backweights and boom not extended. Weight of attachment included.

⁽²⁾ Machine straight, with backweights and boom not extended. Weight of attachment is included. (80% of tipping load).

⁽³⁾ Machine fully articulated, with backweights and boom not extended. Weight of attachment is included.

⁽⁴⁾ Only 6.3+ and 6.3S.

6 SERIES - FEATURES AND OPTIONS

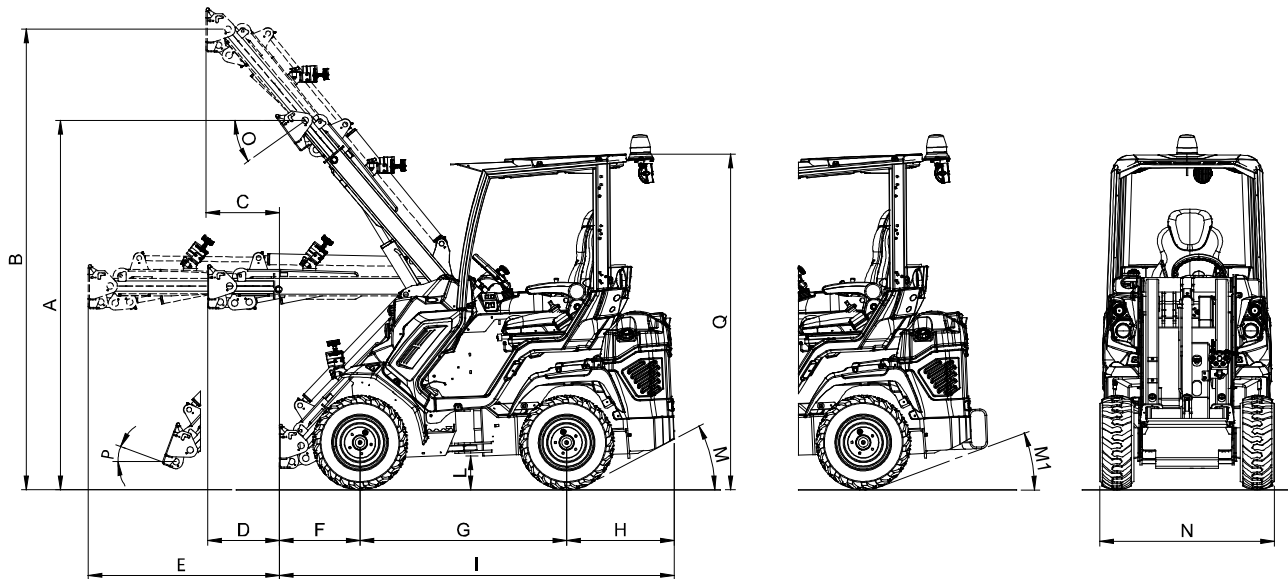

Dimensions (mm / in)

A - Pivot point height (not extended boom)	2290 / 90.1	I - Machine length	2445 / 96.3
B - Pivot point height (extended boom)	2920 / 115	L - Ground clearance	210 / 8.3
C - Outreach with lifted boom (extended boom)	455 / 17.9	M - Angle of departure	28°
D - Outreach with orizontal boom (not extended)	445 / 17.5	M1 - Angle of departure with backweights	21°
E - Outreach with orizontal boom (extended)	1185 / 46.6	N - Max width (with standard tires)	1070 / 42
F - Front length	500 / 19.7	O - Dump angle	36°
G - Wheelbase	1280 / 50.4	P - Rollback angle	29°
H - Rear length	665 / 26.2	Q - Height (with standard tires)	2020 / 79.5

Features

- 4WD hydrostatic Direct Drive motors
- DBS (Dynamic Block System)
- Self-levelling double-H telescopic boom
- 11-functions joystick
- Multi-disk parking brake ⁽⁵⁾
- Radial Piston wheel motor ⁽⁵⁾
- Hydraulic oil cooler
- Hydraulic multiconnector
- ROPS-FOPS Level I
- LCD graphic display with programmed service (tachometer, hour meter, fuel gauge, maintenance light, light indicator and other 14 indicators)
- 2 front working light
- Ergonomic full adjustable suspension seat with armrests and safety belt.

⁽⁵⁾ Only 6.3+ and 6.3S.

6 SERIES - FEATURES AND OPTIONS

Options	Code	Price
Torque divider (only 6.3+ and 6.3S)	C883600	
Torque divider (only 6.3)	C883004	
Floating boom valve	C883011	
Luxury cabin (glass)	C883001	
Heating system	C883601	
Plexiglass windscreen (smart cabin)	C883000	
Plexiglass right side (smart cabin)	C883034	
Plexiglass back window (smart cabin)	C883035	
Led Road lights "Hella"	C883009	
3 additional working led light "Hella"	C883018	
Automatic locking plate	C883038	
Attachment coupling plate for rear mounting	C880031	
Multiconnector to quick coupling 3 lines adapter	C880221	
Trailer coupling	C885014	
Additional backweights (184 kg / 406 lbs)	C880054	
Back up alarm	C883021	
"Luxury" heated seat	C883006	
220 V engine block heater	C885250	
110 V engine block heater	C885255	
Left protection bar for operator	C883020	
Rear 12V electric socket	C883022	
Rear hydraulic outlets - single	C883013	
Rear hydraulic outlets - double	C883014	
Additional front hydraulic outlets	C883024	
Additional front and rear hydraulic outlets - double	C883025	
Wheel spacer 10 mm (0.2 in) (max. 3 pcs for 6.3, max. 1 pcs for 6.3+, 6.3S for wheel)	C880090	
Wheel spacer 55 mm (2.2 in), set of 4	C885010	
Biodegradable oil	C883007	
Snow chains for wheel	see page 57	
Driver area cover	C880049	
Available tires	see page 50	
Beacon light	C883039	